

alea

ESSE SOLUTION SAGL

(CH) 6987 CASLANO +41 76 7585368

www.essesolution.ch info@essesolution.ch

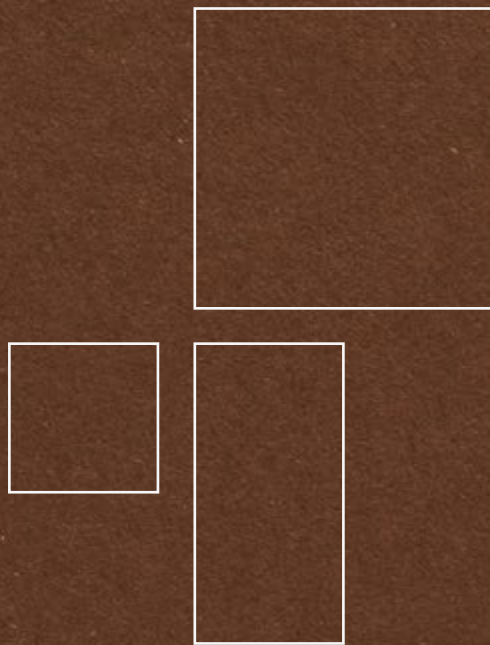

F40

phone booths + pods

Lo spazio assume nuove funzioni

F40 è la collezione di cabine progettate per ricavare angoli di privacy e comfort

Space takes on new functions. F40 is the collection of phone booths and pods designed to create corners of privacy and comfort.

L'espace adopte de nouvelles fonctions. F40 est la collection de box acoustiques conçue pour créer des coins d'intimité et de confort.

El espacio adquiere nuevas funciones. F40 es la colección de cabinas, diseñadas para crear rincones de intimidad y confort.



call



relax



meet





Negli spazi ampi nasce il bisogno di isolarsi per una chiamata oppure un meeting privato, o più semplicemente per ricavarsi un momento di maggiore concentrazione. La collezione di cabine F40 nasce proprio per rispondere a queste esigenze. Si distingue per il design lineare e la rapidità di assemblaggio in cantiere, con conseguente abbattimento dei costi per il cliente.

F40 si presenta in 5 dimensioni che possono accogliere da 1 fino a 8 persone e dove si possono allestire sia gli interni che gli esterni con diverse tipologie di accessori che vanno dal supporto per dispositivi video all'arredo integrato, fino ad arrivare a soluzioni estetiche per l'acustica. Su F40 è possibile addirittura l'applicazione di grafiche alle superfici verticali esterne permettendo così una vera e propria personalizzazione a 360°.

In large spaces there is a need to isolate oneself for a call or a private meeting, or simply to find a moment of greater concentration. The F40 pods and phone booths collection was created to meet these needs. It stands out for its linear design and rapidity of assembly on site, with consequent reduction of costs for the customer.

F40 is available in 5 sizes that can accommodate from 1 up to 8 people. Interiors and exteriors can be outfitted with different types of accessories ranging from TV supports, integrated furniture, to aesthetic solutions for acoustics. External panels can also be personalized using client graphics, allowing a true 360-degree customization.

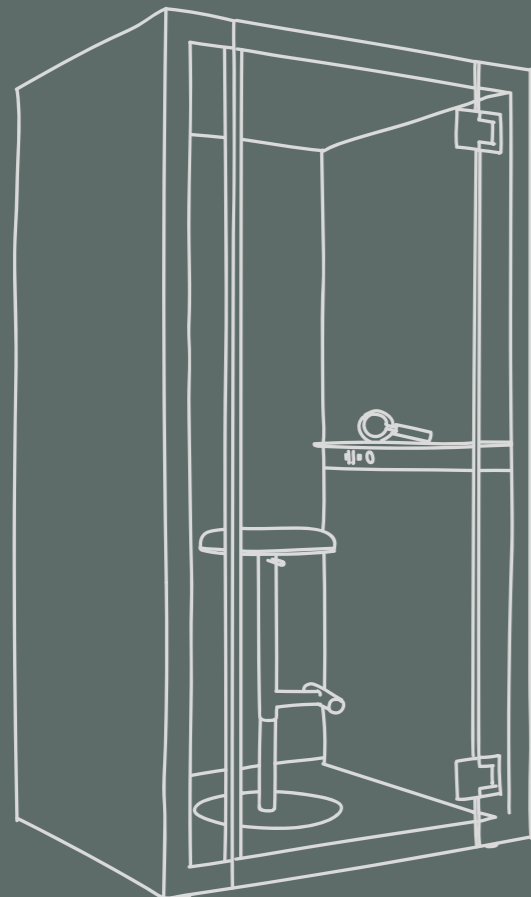

one
two
four
six
eight



Dans les grands espaces, il est nécessaire de s'isoler pour un appel ou une réunion privée, ou simplement pour trouver un moment de plus grande concentration. La collection de pods et cabines F40 a été créée pour répondre à ces besoins. Ils se distinguent par leur conception linéaire et leur rapidité de montage sur site, avec une réduction conséquente des coûts pour le client.

F40 se décline en 5 tailles pouvant accueillir de 1 à 8 personnes et où les intérieurs et les extérieurs peuvent être aménagés avec différents types d'accessoires allant du support pour appareils vidéo aux meubles intégrés, jusqu'aux solutions esthétiques pour l'acoustique. Sur le F40, il est même possible d'appliquer des graphismes sur les surfaces verticales externes, permettant ainsi une véritable personnalisation à 360°.

En los grandes espacios nace la necesidad de aislarse para una llamada o una reunión privada, o simplemente para buscar un momento de mayor concentración. La colección de cabinas F40 se ha creado para satisfacer estas necesidades. Destaca por su diseño lineal y la rapidez de montaje en obra, con la consiguiente reducción de costes para el cliente.

F40 se presenta en 5 tamaños que pueden alojar desde 1 hasta 8 personas, y donde, tanto el interior como el exterior, pueden equiparse con distintos tipos de accesorios: soportes para dispositivos de vídeo y mobiliario integrado, así como soluciones estéticas para la acústica. En F40 es posible incluso aplicar gráficos a las superficies verticales exteriores, permitiendo así una verdadera personalización a 360°.



G Hero Shoes

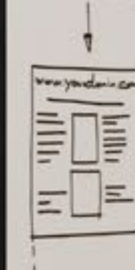

What to do?

- UX
- % Satisfaction
- Inputs!
- Design

BALANCED LAYOUT

#E2DE00
DFD031

10/9

What do they want?

- Sneakers?
- Socks?
- Dress shoes?
- A way to buy?
- Privacy Policy?
- Phone number?



1 | phone booth

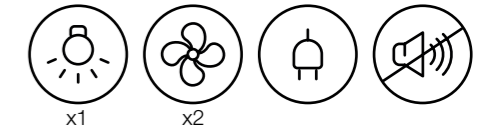

Accessori
Accessories
Accessoires
Accesorios

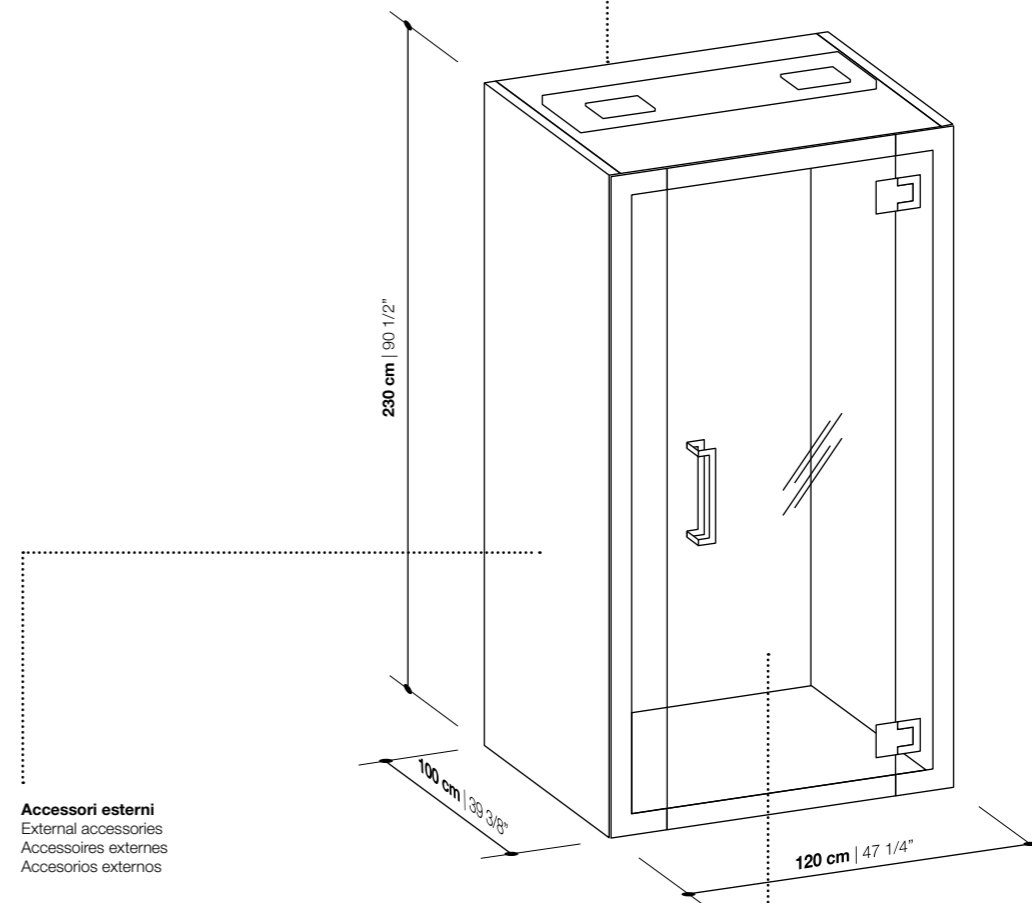
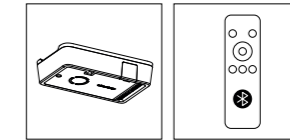

Accessori esterni
External accessories
Accessoires externes
Accesorios externos

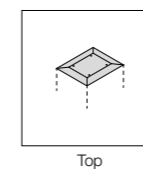
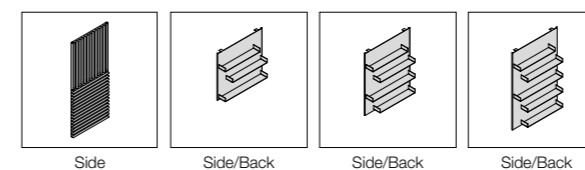
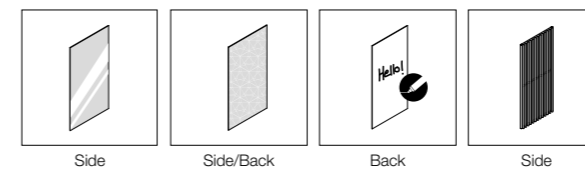

Arredo interno
Interior furniture
Mobilier intérieur
Mobiliario interior

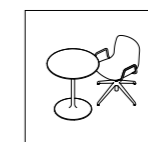
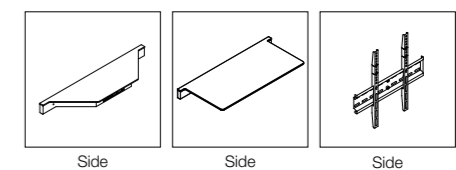



Cablaggio integrato (12 Volt)
 Integrated wiring (12 Volt)
 Câblage intégré (12 Volt)
 Cableado integrado (12 Volt)

Flusso d'aria in entrata
 Incoming air flow
 Flux d'air entrant
 Flujo de aire de entrada

Flusso d'aria in uscita
 Outgoing air flow
 Flux d'air sortant
 Flujo de aire de salida



Luce LED con sensore di movimento
 LED light with motion sensor
 LED avec détecteur de mouvement
 Luz LED con detector de movimiento

Sanificatore (opzionale)
 Air sanitiser (optional)
 Purificateur d'air (optionnel)
 Purificador de aire (opcional)

Prese elettriche (opzionale)
 Power socket (optional)
 Prises électriques (optionnel)
 Tomas eléctricas (opcional)

Ventilazione integrata con sensore di movimento
 Integrated ventilation system with motion sensor
 Ventilation intégrée avec détecteur de mouvement
 Ventilación integrada con sensor de movimiento

Supporto TV (opzionale)
 TV support (optional)
 Support écran TV (optionnel)
 Soporte de TV (opcional)

Input elettrico
 Electric input
 Entrée électrique
 Entrada eléctrica



ESSE SOLUTION SAGL

(CH) 6987 CASLANO +41 76 7585368

www.essesolution.ch info@essesolution.ch

/TWO

2  meeting pod

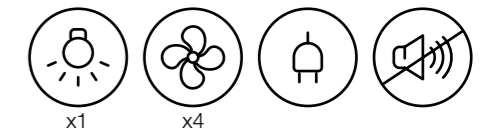

Accessori
Accessories
Accessoires
Accesorios

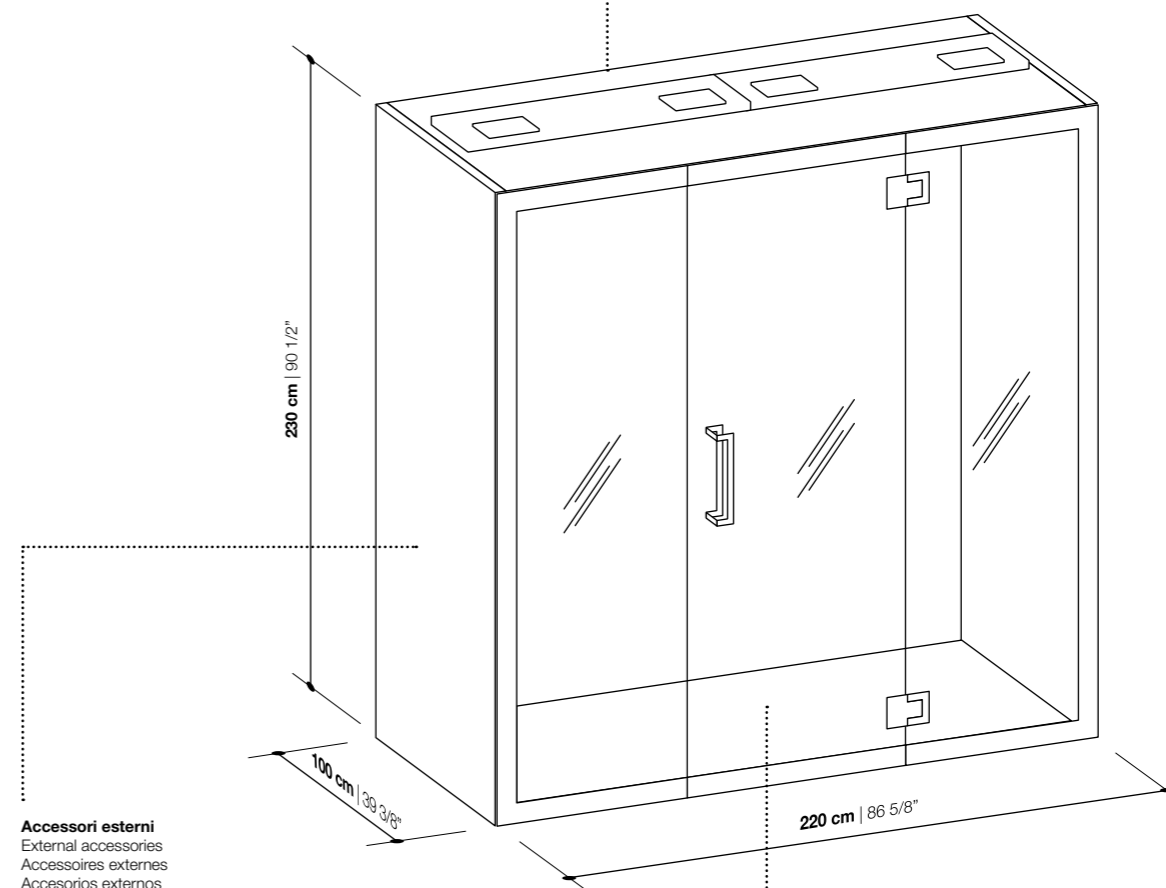
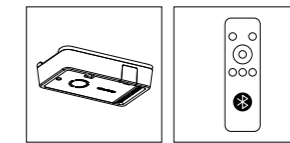

Accessori esterni
External accessories
Accessoires externes
Accesorios externos

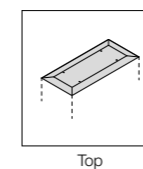
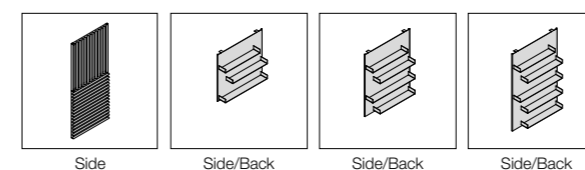
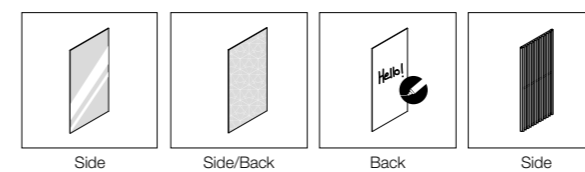

Arredo interno
Interior furniture
Mobilier intérieur
Mobiliario interior

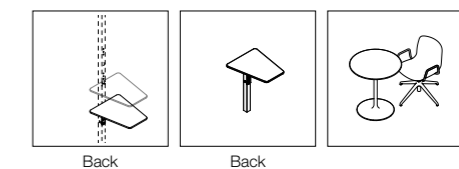
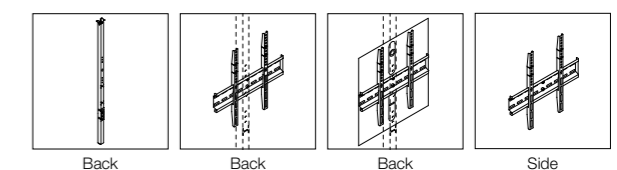

ESSE SOLUTION SAGL

(CH) 6987 CASLANO +41 76 7585368

www.essesolution.ch info@essesolution.ch



Cablaggio integrato (12 Volt)
Integrated wiring (12 Volt)
Câblage intégré (12 Volt)
Cableado integrado (12 Volt)

Flusso d'aria in entrata
Incoming air flow
Flux d'air entrant
Flujo de aire de entrada

Flusso d'aria in uscita
Outgoing air flow
Flux d'air sortant
Flujo de aire de salida

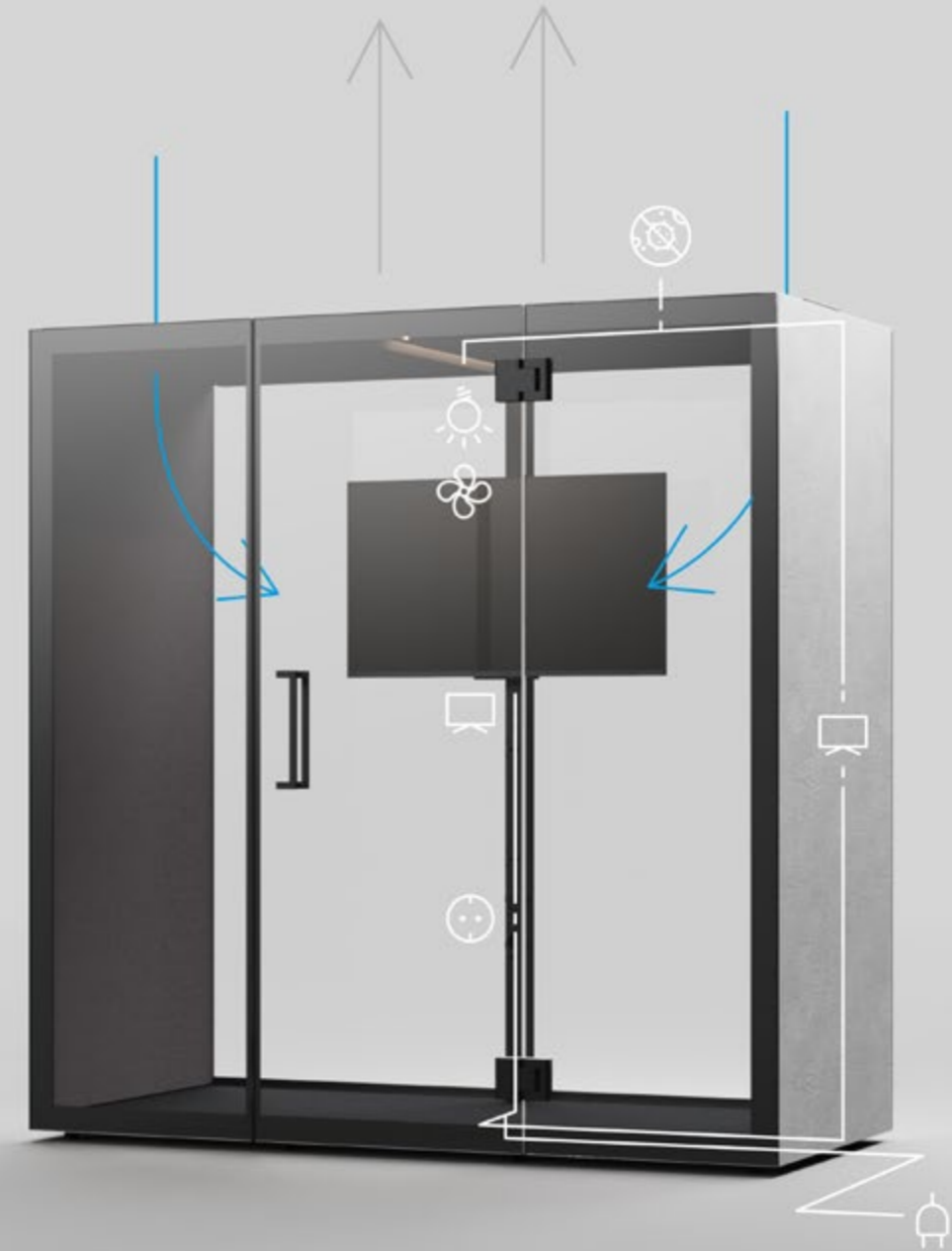

Luce LED con sensore di movimento
LED light with motion sensor
LED avec détecteur de mouvement
Luz LED con detector de movimiento

Ventilazione integrata con sensore di movimento
Integrated ventilation system with motion sensor
Ventilation intégrée avec détecteur de mouvement
Ventilación integrada con sensor de movimiento

Sanificatore (opzionale)
Air sanitiser (optional)
Purificateur d'air (optionnel)
Purificador de aire (opcional)

Supporto TV (opzionale)
TV support (optional)
Support écran TV (optionnel)
Soporte de TV (opcional)

Prese elettriche (opzionale)
Power socket (optional)
Prises électriques (optionnel)
Tomas eléctricas (opcional)

Input elettrico
Electric input
Entrée électrique
Entrada eléctrica

ESSE SOLUTION SAGL

(CH) 6987 CASLANO +41 76 7585368
www.essesolution.ch info@essesolution.ch



4  meeting pod

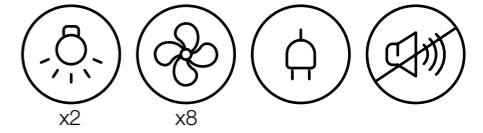

Accessori
 Accessories
 Accessoires
 Accesorios

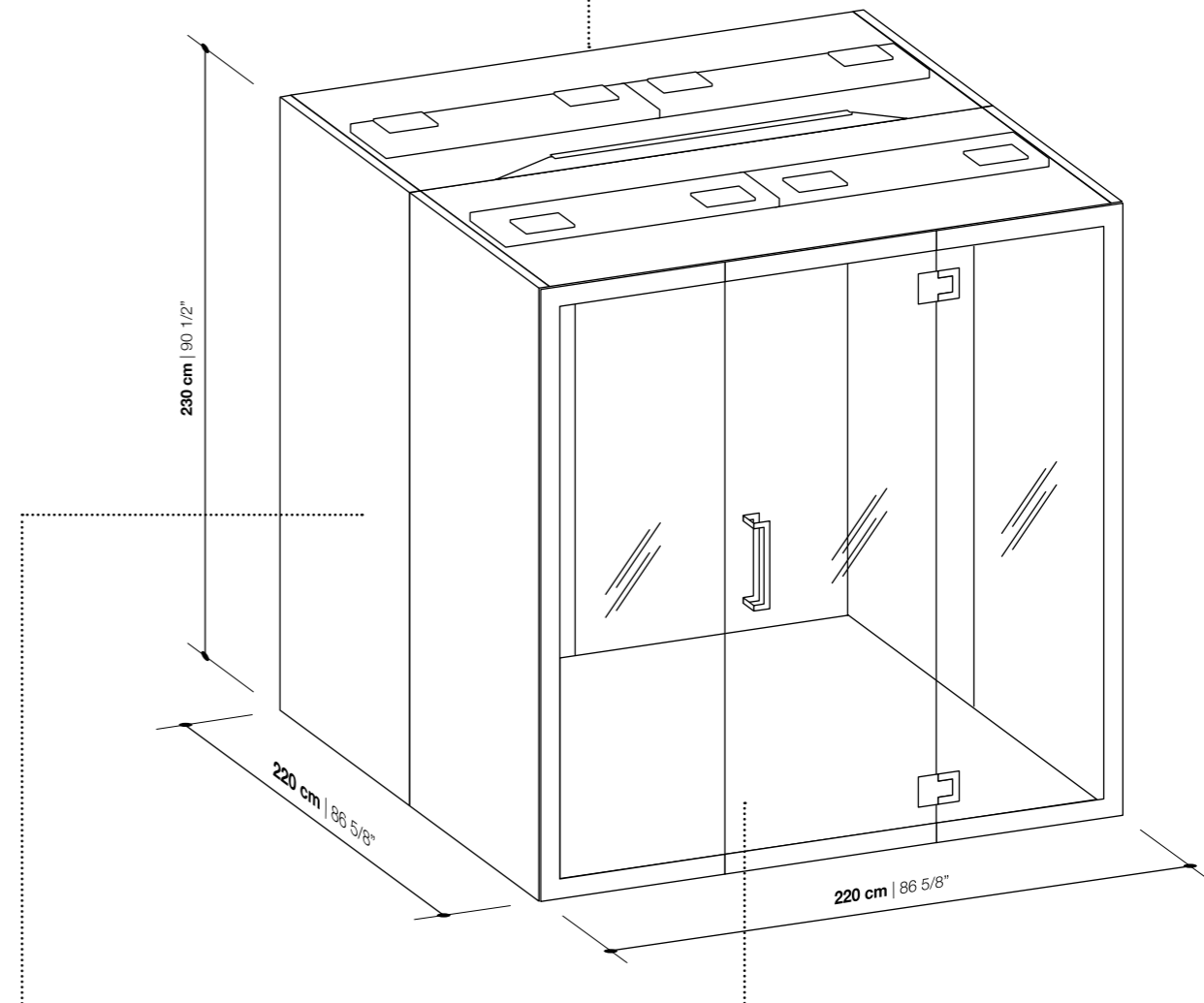
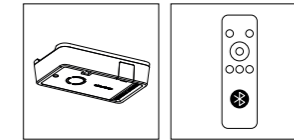

Accessori esterni
 External accessories
 Accessoires externes
 Accesorios externos

Arredo interno
 Interior furniture
 Mobilier intérieur
 Mobiliario interior

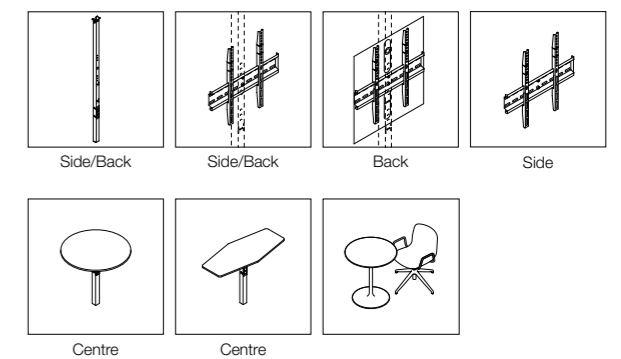
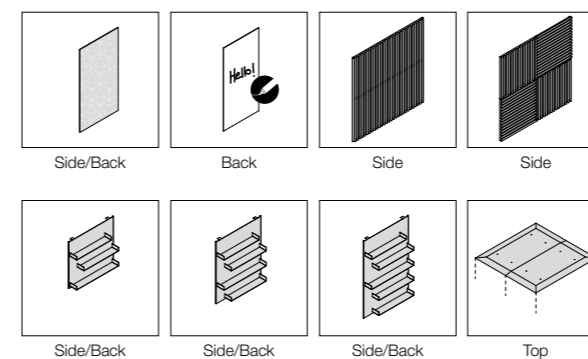

ESSE SOLUTION SAGL

(CH) 6987 CASLANO +41 76 7585368

www.essesolution.ch info@essesolution.ch



Cablaggio integrato (24 Volt)
Integrated wiring (24 Volt)
Câblage intégré (24 Volt)
Cableado integrado (24 Volt)

Flusso d'aria in entrata
Incoming air flow
Flux d'air entrant
Flujo de aire de entrada

Flusso d'aria in uscita
Outgoing air flow
Flux d'air sortant
Flujo de aire de salida

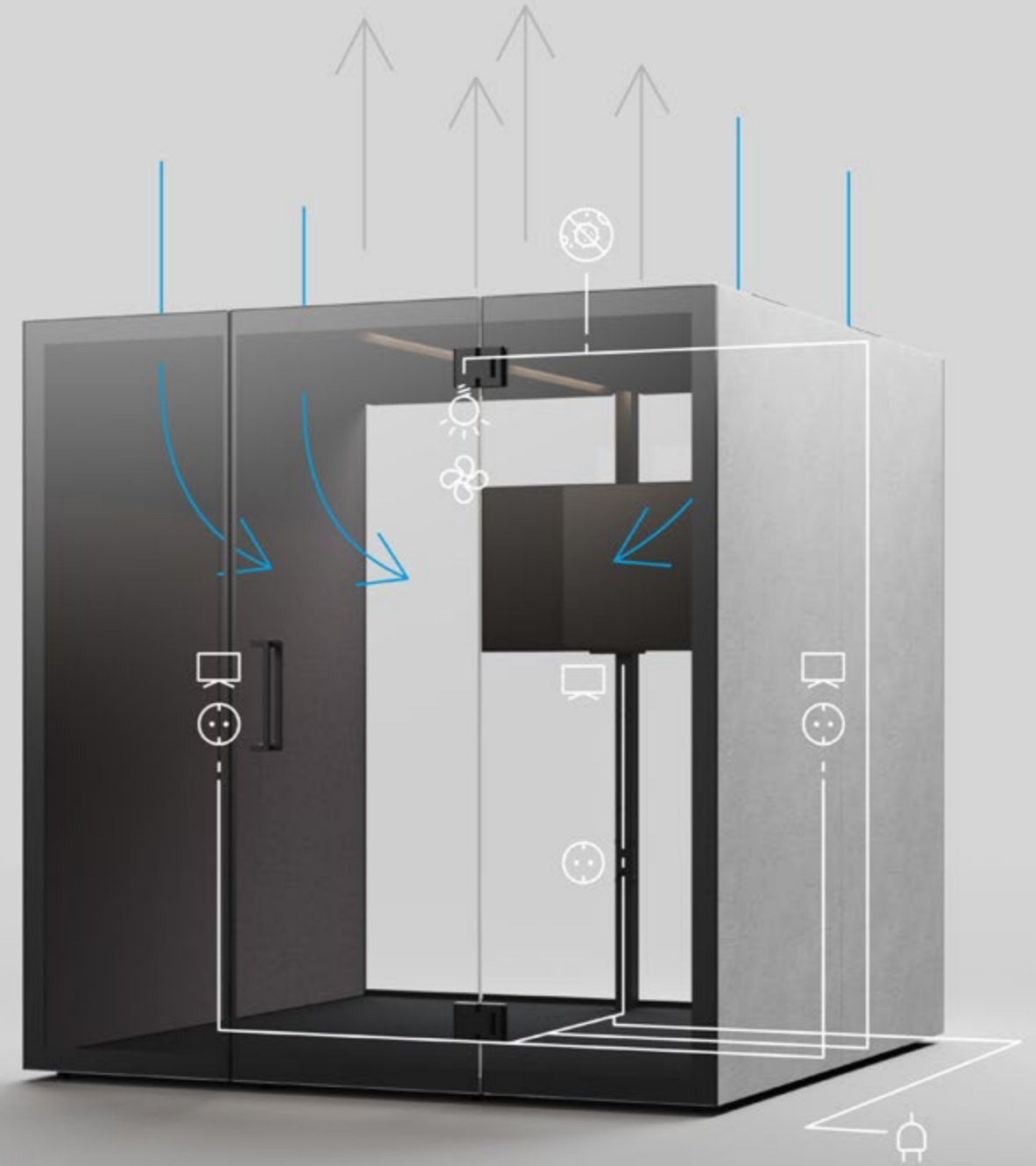

Luce LED con sensore di movimento
LED light with motion sensor
LED avec détecteur de mouvement
Luz LED con detector de movimiento

Sanificatore (opzionale)
Air sanitiser (optional)
Purificateur d'air (optionnel)
Purificador de aire (opcional)

Prese elettriche (opzionale)
Power socket (optional)
Prises électriques (optionnel)
Tomas eléctricas (opcional)

Ventilazione integrata con sensore di movimento
Integrated ventilation system with motion sensor
Ventilation intégrée avec détecteur de mouvement
Ventilación integrada con sensor de movimiento

Supporto TV (opzionale)
TV support (optional)
Support écran TV (optionnel)
Soporte de TV (opcional)

Input elettrico
Electric input
Entrée électrique
Entrada eléctrica



6 | meeting pod

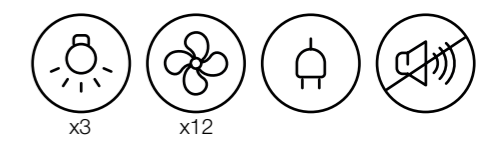

Accessori
Accessories
Accessoires
Accesorios

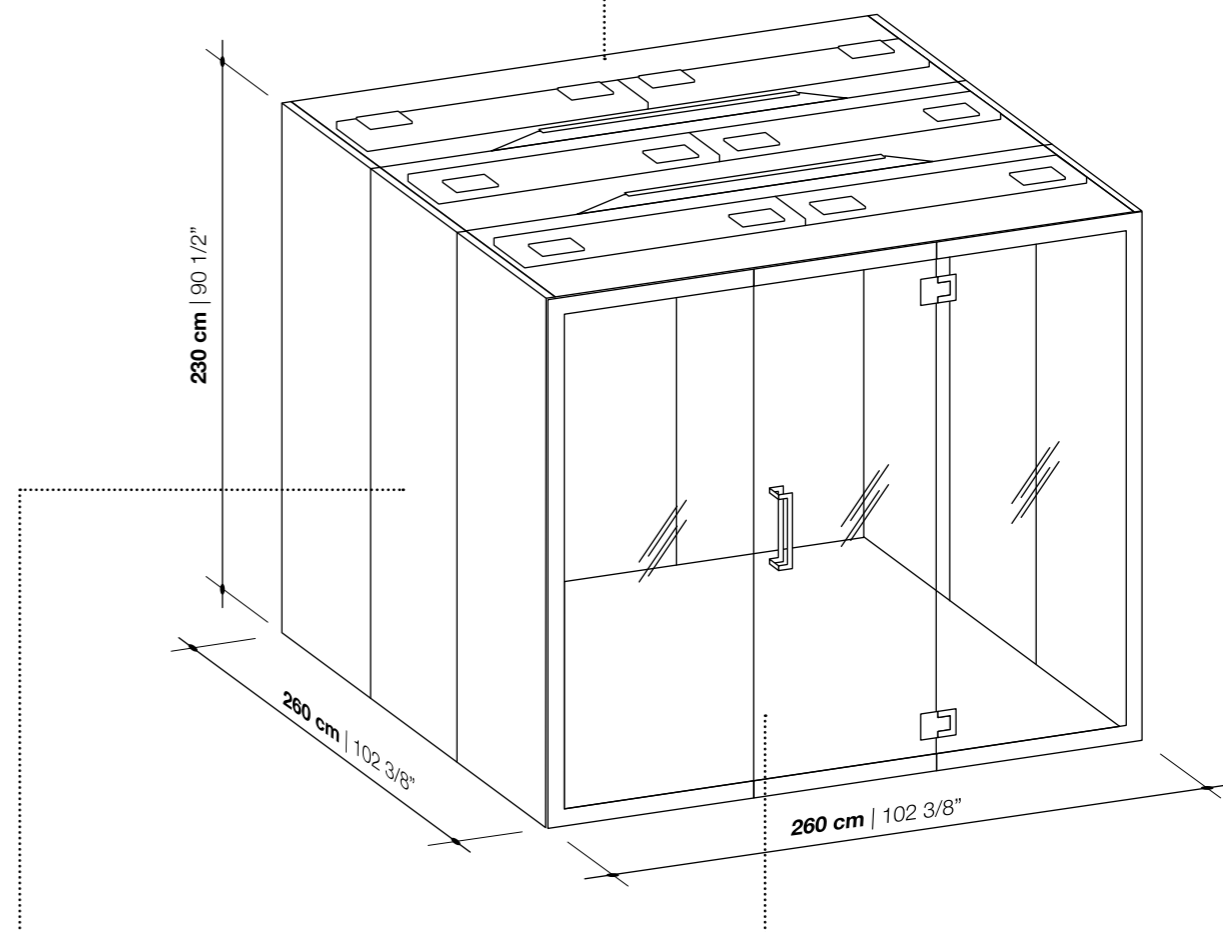
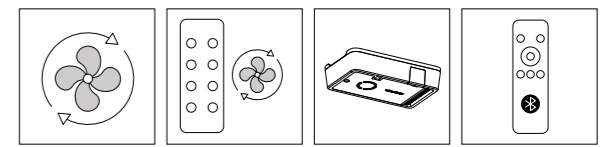

Accessori esterni
External accessories
Accessoires externes
Accesorios externos

Arredo interno
Interior furniture
Mobilier intérieur
Mobiliario interior

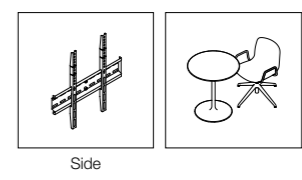
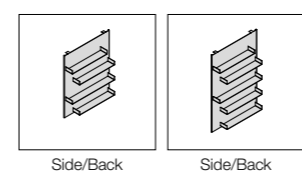
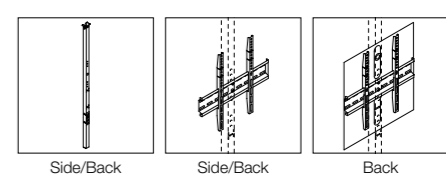
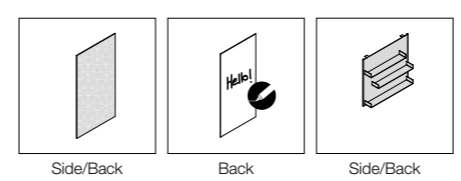

ESSE SOLUTION SAGL

(CH) 6987 CASLANO +41 76 7585368

www.essesolution.ch info@essesolution.ch

/SIX

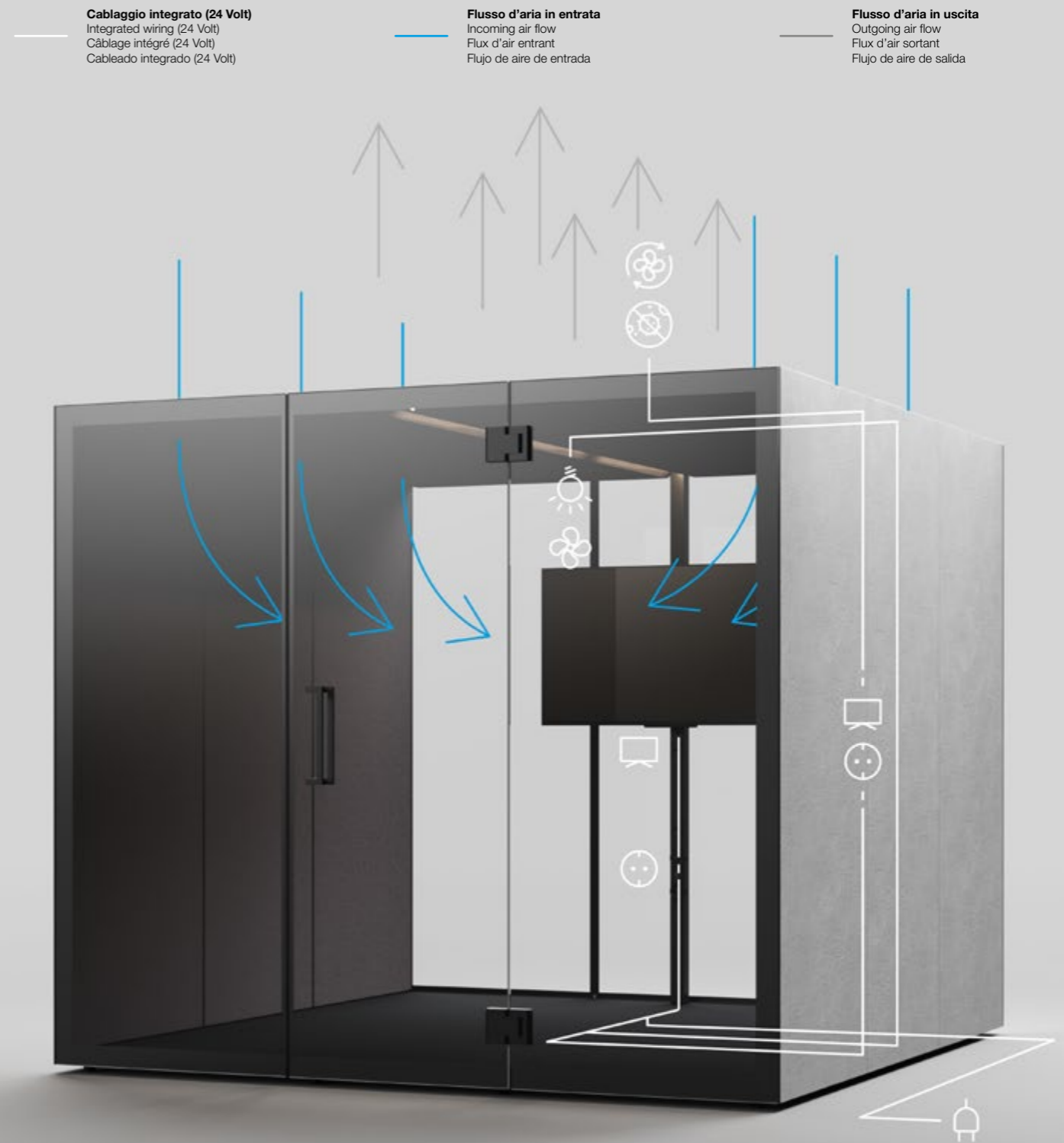

Cablaggio integrato (24 Volt)
Integrated wiring (24 Volt)
Câblage intégré (24 Volt)
Cableado integrado (24 Volt)

Flusso d'aria in entrata
Incoming air flow
Flux d'air entrant
Flujo de aire de entrada

Flusso d'aria in uscita
Outgoing air flow
Flux d'air sortant
Flujo de aire de salida

Luce LED con sensore di movimento
LED light with motion sensor
LED avec détecteur de mouvement
Luz LED con detector de movimiento

Ventilazione integrata con sensore di movimento
Integrated ventilation system with motion sensor
Ventilation intégrée avec détecteur de mouvement
Ventilación integrada con sensor de movimiento

Ventilazione meccanica forzata (opzionale)
Mechanical forced ventilation (optional)
Ventilation mécanique contrôlée (optionnel)
Ventilación mecánica forzada (opcional)

Sanificatore (opzionale)
Air sanitiser (optional)
Purificateur d'air (optionnel)
Purificador de aire (opcional)

Supporto TV (opzionale)
TV support (optional)
Support écran TV (optionnel)
Soporte de TV (opcional)

Prese elettriche (opzionale)
Power socket (optional)
Prises électriques (optionnel)
Tomas eléctricas (opcional)

Input elettrico
Electric input
Entrée électrique
Entrada eléctrica



8  meeting pod

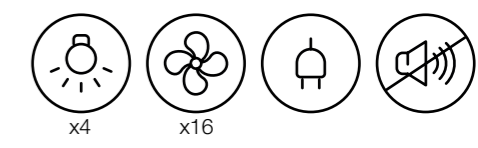

Accessori
Accessories
Accessoires
Accesorios

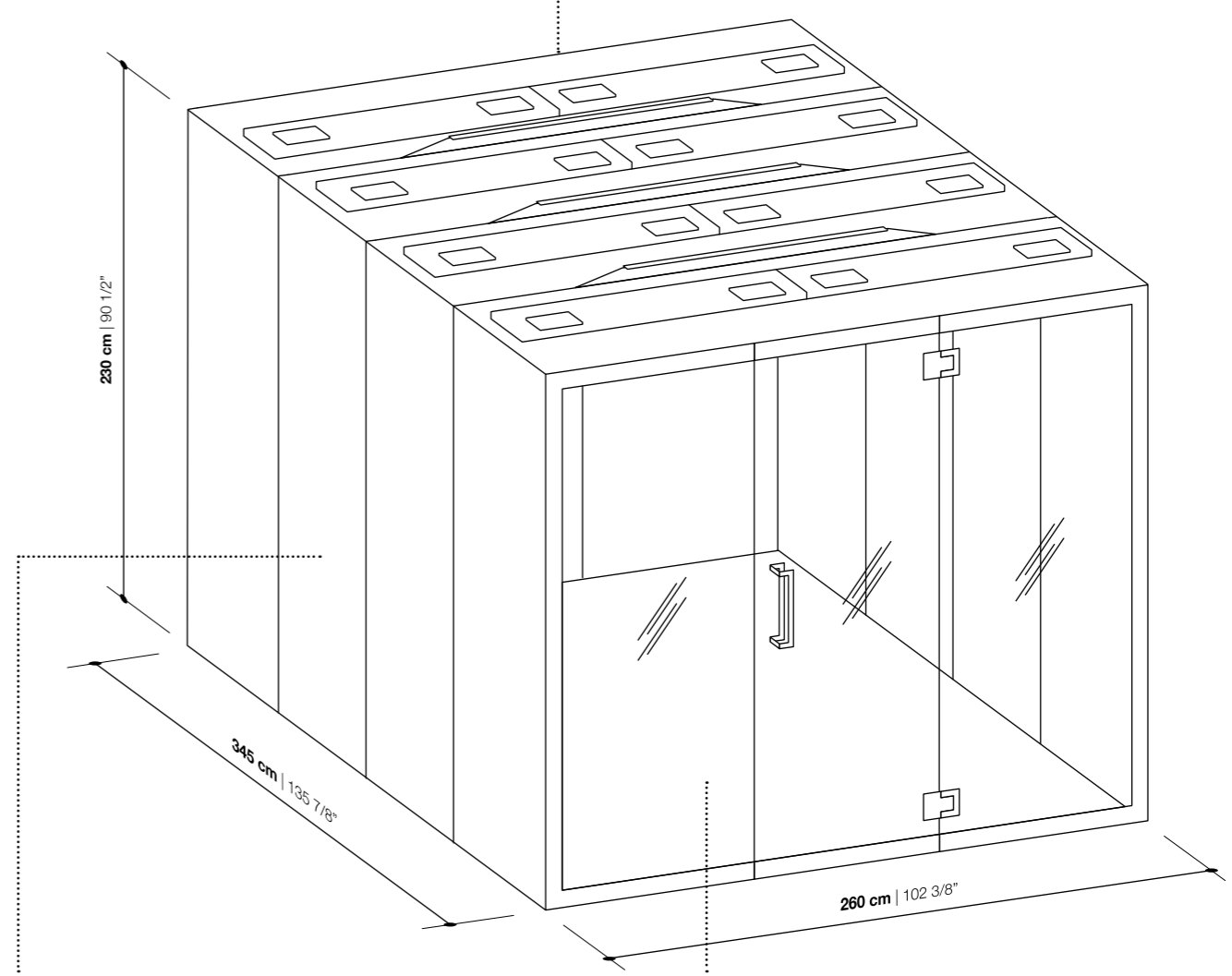
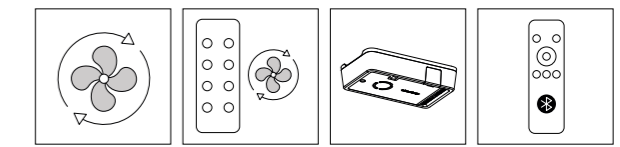

Accessori esterni
External accessories
Accessoires externes
Accesorios externos

Arredo interno
Interior furniture
Mobilier intérieur
Mobiliario interior

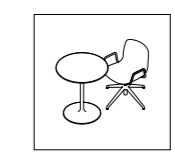
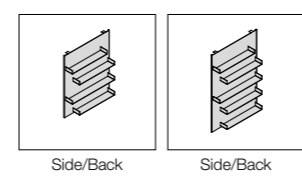
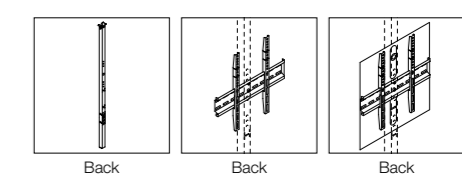
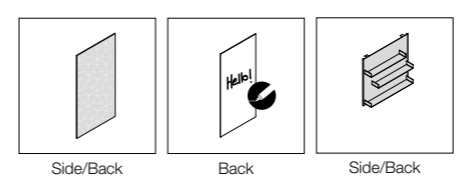

ESSE SOLUTION SAGL

(CH) 6987 CASLANO +41 76 7585368

/EIGHT

www.essesolution.ch info@essesolution.ch



Cablaggio integrato (24 Volt)
 Integrated wiring (24 Volt)
 Câblage intégré (24 Volt)
 Cableado integrado (24 Volt)

Flusso d'aria in entrata
 Incoming air flow
 Flux d'air entrant
 Flujo de aire de entrada

Flusso d'aria in uscita
 Outgoing air flow
 Flux d'air sortant
 Flujo de aire de salida

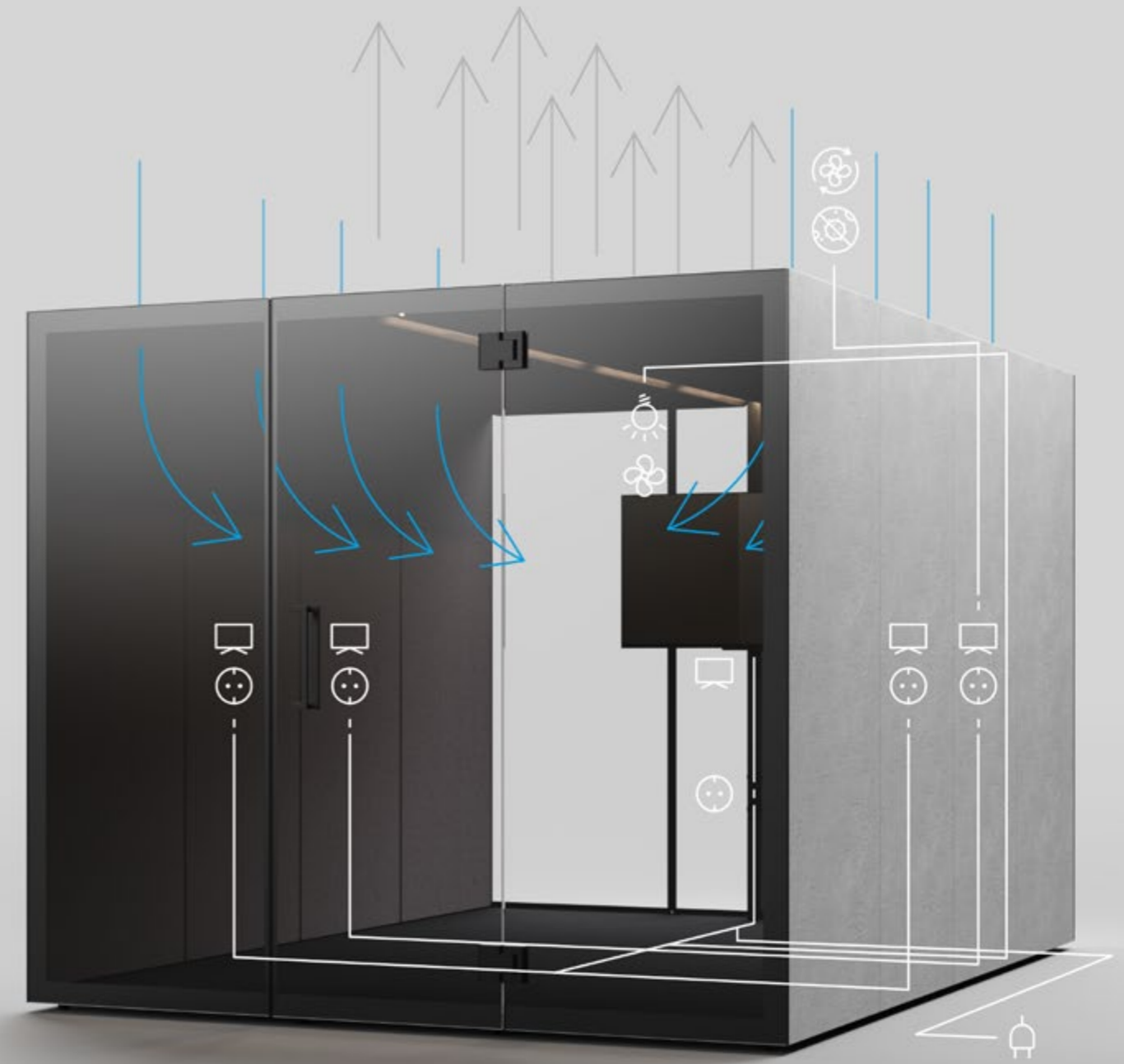

Luce LED con sensore di movimento
 LED light with motion sensor
 LED avec détecteur de mouvement
 Luz LED con detector de movimiento

Ventilazione integrata con sensore di movimento
 Integrated ventilation system with motion sensor
 Ventilation intégrée avec détecteur de mouvement
 Ventilación integrada con sensor de movimiento

Ventilazione meccanica forzata (opzionale)
 Mechanical forced ventilation (optional)
 Ventilation mécanique contrôlée (optionnel)
 Ventilación mecánica forzada (opcional)

Sanificatore (opzionale)
 Air sanitiser (optional)
 Purificateur d'air (optionnel)
 Purificador de aire (opcional)

Supporto TV (opzionale)
 TV support (optional)
 Support écran TV (optionnel)
 Soporte de TV (opcional)

Prese elettriche (opzionale)
 Power socket (optional)
 Prises électriques (optionnel)
 Tomas eléctricas (opcional)

Input elettrico
 Electric input
 Entrée électrique
 Entrada eléctrica



Mensola con prese integrate
Shelf with integrated power module
Étagère avec prises intégrées
Estante con enchufes integrados

ONE



Mensola con prese integrate
Shelf with integrated power module
Étagère avec prises intégrées
Estante con enchufes integrados

ONE



Supporto TV per schiena melaminico
TV support for melamine back
Support TV pour fond en mélaminé
Soporte de TV para trasera en melamina

TWO / FOUR / SIX / EIGHT



Supporto TV per schiena vetro
TV support for glass back
Support TV pour fond en verre
Soporte de TV para trasera en vidrio

TWO / FOUR / SIX / EIGHT

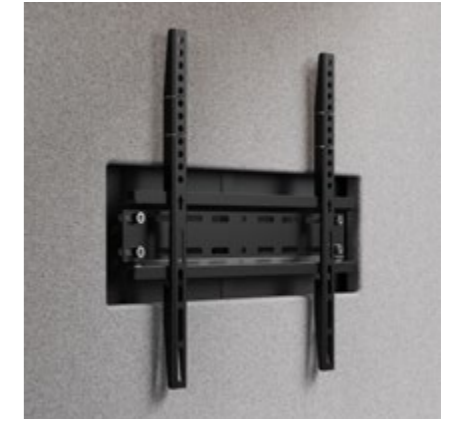

Supporto TV integrato
Integrated TV support
Support écran TV intégré
Soporte para TV integrado

ONE / TWO / FOUR / SIX



Tavolo regolabile in 2 posizioni
2-position adjustable table
Table réglable en 2 positions
Mesa regulable en 2 posiciones

TWO



Tavolo a trapezio, prese integrate
Trapezoidal table, integrated power module
Table trapézoïdale, prises intégrées
Mesa trapezoidal, enchufes integrados

TWO



Tavolo rotondo, prese integrate
Round table, integrated power module
Table ronde, prises intégrées
Mesa redonda, enchufes integrados

FOUR



Schiena scrivibile
Writable back
Fond inscriptible
Trasera escribible

ONE / TWO / FOUR / SIX / EIGHT



Specchio per fianco
Side mirror
Miroir pour coté
Especjo para costado

ONE / TWO



Stampa UV
UV print
Impression UV
Impresión UV

ONE / TWO / FOUR / SIX / EIGHT



Tavolo esagonale, prese integrate
Hexagonal table, integrated power module
Table hexagonale, prises intégrées
Mesa hexagonal, enchufes integrados

FOUR



Colonna tecnica con prese integrate
Column with integrated power module
Colonne avec prises intégrées
Columna con enchufes integrados

TWO / FOUR / SIX / EIGHT



Pannelli acustici con doghe verticali
Acoustic panels with vertical planks
Panneaux insonorisants, planches verticales
Paneles acústicos con lamas verticales

ONE / TWO / FOUR

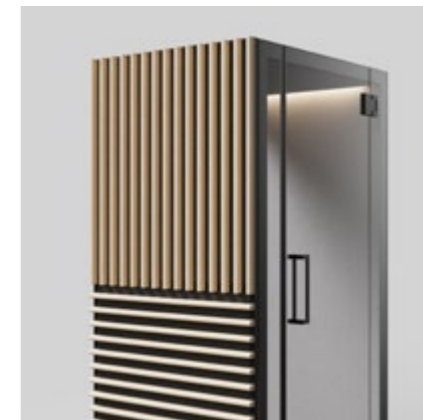

Pannelli acustici con doghe miste
Acoustic panels with mixed planks
Panneaux insonorisants, planches mixtes
Paneles acústicos con lamas mixtas

ONE / TWO / FOUR



Elemento con 3 mensole
Element with 3 shelves
Élément avec 3 étagères
Elemento con 3 estantes

ONE / TWO / FOUR / SIX / EIGHT



Elemento con 4 mensole
 Element with 4 shelves
 Élément avec 4 étagères
 Elemento con 4 estantes

ONE / TWO / FOUR / SIX / EIGHT



Elemento con 5 mensole
 Element with 5 shelves
 Élément avec 5 étagères
 Elemento con 5 estantes

ONE / TWO / FOUR / SIX / EIGHT



Top di copertura
 Covering top
 Dessus
 Cubierta superior

ONE / TWO / FOUR



Ventilazione meccanica forzata
 Mechanical forced ventilation
 Ventilation mécanique contrôlée
 Ventilación mecánica forzada

SIX / EIGHT

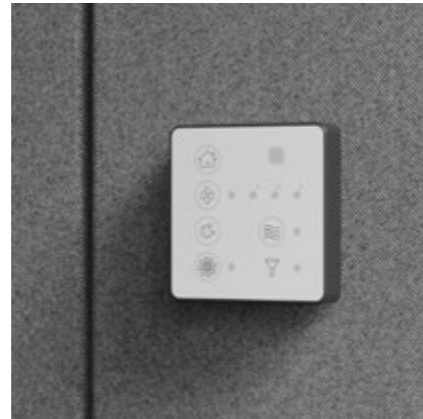

Telecomando per ventilazione forzata
 Remote for forced ventilation
 Télécommande pour ventilation contrôlée
 Mando a distancia para ventilación forzada

SIX / EIGHT



Sanificatore d'aria
 Air sanitiser
 Purificateur d'air
 Purificador de aire

ONE / TWO / FOUR / SIX / EIGHT



Dimmer per illuminazione e ventilazione
 Lighting and ventilation dimmer
 Dimmer pour illumination et ventilation
 Dimmer para iluminación y ventilación

ONE / TWO / FOUR / SIX / EIGHT

Go to our website and configure now



or find us on **pCon**

1
TY
INATION
RE
46° S 354° 28' 24" E



ESSE SOLUTION SAGL

(CH) 6987 CASLANO +41 76 7585368

www.essesolution.ch info@essesolution.ch

Finiture | Finishes | Finitions | Acabados

MEL

Melaminico

Melamine | Mèlaminé | Melamínico

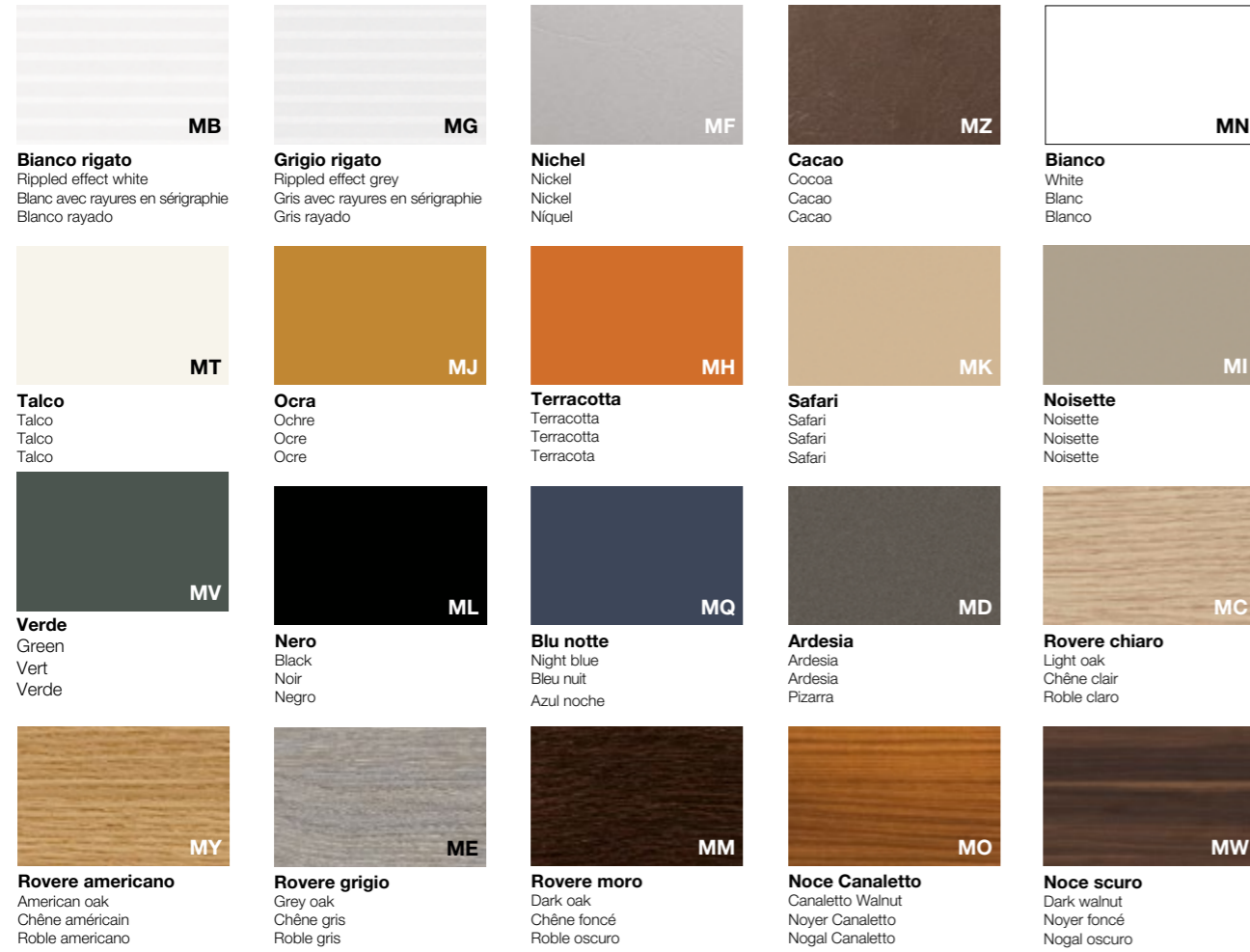

TES

Tessuto

Fabric | Tissu | Tejido

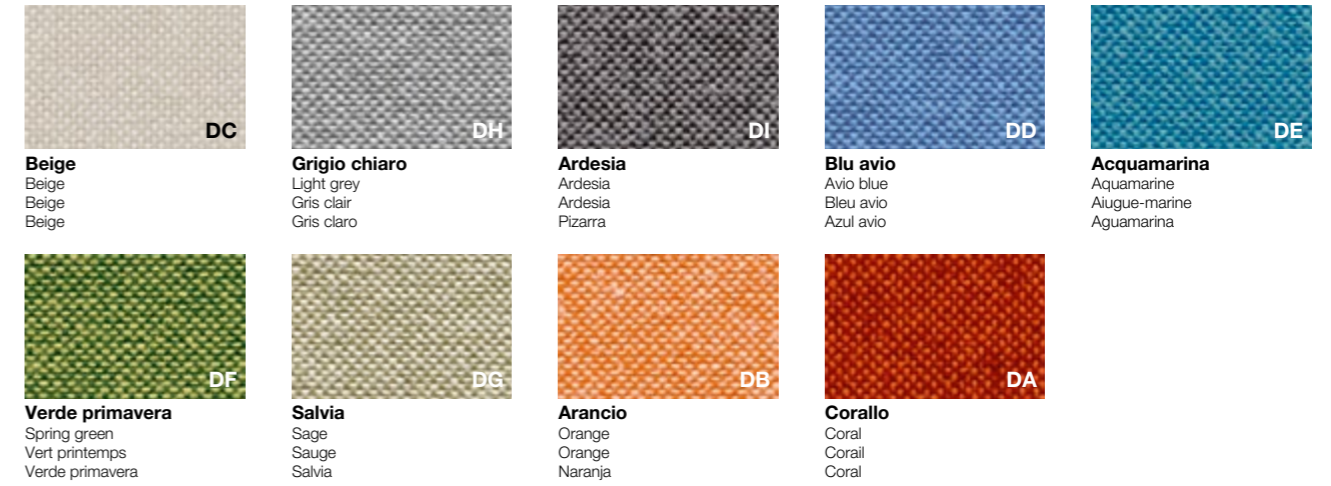

MOQ

Moquette

Carpet | Moquette | Moqueta



Le finiture contenute nella stampa sono puramente indicative e non sono di riferimento per le finiture del prodotto
Due to the printing process, finishes shown in this document are for illustration only. The finish on the final item may differ slightly from the printed illustration
Les finitions contenues dans l'impression sont purement indicatives et ne sont pas pertinentes pour les finitions du produit
Los acabados contenidos en la impresión son puramente indicativos y no son de referencia para los suministros del producto

Ambiente e sicurezza | Environment and safety | Environnement et sécurité | Medio ambiente y seguridad

Ecologia: Alea utilizza per i suoi prodotti e i suoi imballi materiali facilmente separabili e riciclabili. (Immagine 1)

Catena Di Custodia COC: Alea si impegna ad utilizzare materiali legnosi certificati FSC® e pannelli a base di legno con certificazione CARB2.

I pannelli CARB2 presentano un rilascio di formaldeide inferiore rispetto al pannello E1 comunemente utilizzato (classe E1 secondo il DM 10/10/2008).

I prodotti certificati FSC® (License Code FSC-C118323) sono disponibili su richiesta: contattate i nostri uffici per maggiori informazioni. (Immagine 2)

LEED: Gli arredi di Alea possono contribuire al conseguimento del punteggio di certificazione LEED per i crediti indicati nei product badge. (Immagine 3)

Sistemi di Gestione certificati ISO 9001, ISO 14001, ISO 45001: Alea è attivamente impegnata nel raggiungere standard elevati di qualità e responsabilità attraverso l'adozione di sistemi di gestione certificati ISO per garantire prodotti e servizi di elevata qualità, in grado di soddisfare le aspettative dei clienti, di assicurare un ambiente di lavoro sicuro e di monitorare regolarmente l'impatto ambientale delle nostre attività. (Immagine 4)

Attestazione di prodotto: I prodotti Alea sono stati sottoposti a prove prestazionali presso laboratori di prova accreditati.

Copia dei rapporti di prova o delle attestazioni di conformità sono disponibili su richiesta. (Immagine 5)

Eco-friendly: Alea uses easily separable and recyclable materials for its products and packaging. (Image 1)

Chain of Custody (COC): Alea is committed to using FSC® certified wood materials and CARB2-certified wood-based panels. CARB2 panels have lower formaldehyde emissions compared to the commonly used E1 panels (class E1 according to the DM 10/10/2008). FSC® certified products (License Code FSC-C118323) are available upon request: please contact our offices for more information. (Image 2)

LEED: The A65 system can contribute to obtaining LEED certification points for the credits indicated in the product badges. (Image 3)

ISO 9001, ISO 14001, ISO 45001 Certified Management Systems: Alea is actively committed to achieving high standards of quality and responsibility through the adoption of ISO certified management systems to ensure high-quality products and services that meet customer expectations, provide a safe working environment, and regularly monitor the environmental impact of our activities. (Image 4)

Product Certification: Alea products have undergone performance tests by accredited testing laboratories. Copies of test reports or certificates of conformity are available upon request. (Image 5)



Ambiente e sicurezza | Environment and safety | Environnement et sécurité | Medio ambiente y seguridad

Écologie: Alea utilise pour ses produits et ses emballages des matériaux facilement séparables et recyclables. (Image 1)

Chaîne de contrôle COC: Alea a à cœur d'utiliser des matériaux en bois certifiés FSC® et des panneaux à base de bois avec la certification CARB2.

Les panneaux CARB2 présentent une émission de formaldéhyde inférieure à celle des panneaux E1 couramment utilisés (classe E1 selon le DM 10/10/2008). Les produits certifiés FSC® (Code de licence FSC-C118323) sont disponibles sur demande : veuillez contacter nos bureaux pour plus d'informations. (Image 2)

LEED: Le système A65 peut contribuer à l'obtention des points de certification LEED pour les crédits indiqués dans les badges produits. (Image 3)

Systèmes de gestion certifiés ISO 9001, ISO 14001, ISO 45001: Alea s'engage activement à atteindre des normes élevées de qualité et de responsabilité à travers l'adoption de systèmes de gestion certifiés ISO pour garantir des produits et services de haute qualité, répondre aux attentes des clients, assurer un environnement de travail sûr et surveiller régulièrement l'impact environnemental de nos activités. (Image 4)

Attestation de produit: Les produits Alea ont été soumis à des tests de performance dans des laboratoires d'essais accrédités. Des copies des rapports de tests ou des certificats de conformité sont disponibles sur demande. (Image 5)

Ecología: Alea utiliza para sus productos y embalajes materiales fácilmente separables y reciclables. (Imagen 1)

Cadena de Custodia COC: Alea se compromete a utilizar materiales de madera certificados por FSC® y paneles a base de madera con certificación CARB2.

Los paneles CARB2 presentan una emisión de formaldehído inferior en comparación con los paneles E1 comúnmente utilizados (clase E1 según el DM 10/10/2008). Los productos certificados por FSC® (Código de Licencia FSC-C118323) están disponibles bajo solicitud: por favor contacte a nuestras oficinas para más información. (Imagen 2)

LEED: El sistema A65 puede contribuir a la consecución de la puntuación de certificación LEED para los créditos indicados en los product badges. (Imagen 3)

Sistemas de Gestión Certificados ISO 9001, ISO 14001, ISO 45001: Alea está comprometida activamente en alcanzar altos estándares de calidad y responsabilidad mediante la adopción de sistemas de gestión certificados por ISO para garantizar productos y servicios de alta calidad, que cumplen con las expectativas de los clientes, aseguran un entorno de trabajo seguro y monitorean regularmente el impacto ambiental de nuestras actividades. (Imagen 4)

Certificación de Producto: Los productos Alea han sido sometidos a pruebas de rendimiento en laboratorios acreditados. Las copias de los informes de prueba o los certificados de conformidad están disponibles bajo solicitud. (Imagen 5)



ESSE SOLUTION SAGL

(CH) 6987 CASLANO +41 76 7585368

www.essesolution.ch info@essesolution.ch

alea
aleaoffice.com

Concept, visual & graphic design

Alea marketing + communication

Design

Mirto Antonel

Art direction

Mirto Antonel

Si ringrazia M.artedesign

martedesign.it

AD/CACD/AD

Le immagini dei prodotti visibili all'interno di questo catalogo sono inserite a scopo puramente indicativo
The images of the products visible in this catalogue are included for information purposes only
Les images des produits visibles dans ce catalogue sont incluses à titre informatif uniquement
Las imágenes de los productos visibles en este catálogo se incluyen sólo con fines informativos



ALEA HQ AND SHOWROOM: Via Col de Rust, 19 - 33070 Sarone di Caneva (PN), Italia - tel +39 0434 777333
www.aleaoffice.com - email info@aleaoffice.com **MILAN SHOWROOM:** Via Cino del Duca, 2 - 20122 Milano, Italia - email info@aleaoffice.com
PARIS SHOWROOM: TOUR EMBLEM - Paris la Défense, 7 Allée de l'Arche - 92400 Courbevoie, France - email france@aleaoffice.com
LONDON SHOWROOM: 50-54 Clerkenwell Road - London, EC1M 5PS - email ukoffice@aleaoffice.com **NEW YORK SHOWROOM:** 25W, 31st Street, #9 - New York, NY 10001, USA - tel +1 305 4701200 - email info@alea-usa.com **MIAMI SHOWROOM:** Midtown 2, 3449 NE 1st Avenue L-32 - Miami, FL 33137, USA - tel +1 305 4701200 - email info@alea-usa.com